

System	Max. Height (mm)	Max. Panel Width (mm)	Min. Panel Width (mm)
Tiara 08	2400	800	200
Tiara 10	2600	800	200
Tiara 12	2600	800	200
Tiara Twin (4+20+4)	2800	800	200
Tiara Twin (5+18+5)	2500	800	200
Tiara 08 Flat & Slim & Zero	2400*	800	200
Tiara 10 Flat & Slim & Zero	2600*	800	200
Tiara 12 Flat & Slim & Zero	2600*	800	200
Tiara Twin Flat & Slim & Zero (4+20+4)	2800	800	200
Tiara Twin Flat & Slim & Zero (5+18+5)	2500	800	200
Tiara INT 08	2400**	800	200
Tiara INT 10	2600**	800	200
Tiara INT 12	2600**	800	200
Tiara INT Twin (4+20+4)	2800	800	200
Tiara INT Twin (5+18+5)	2500	800	200

*Recommended with Height Adjustment Profile

** Recommended with Confort Lock Profile

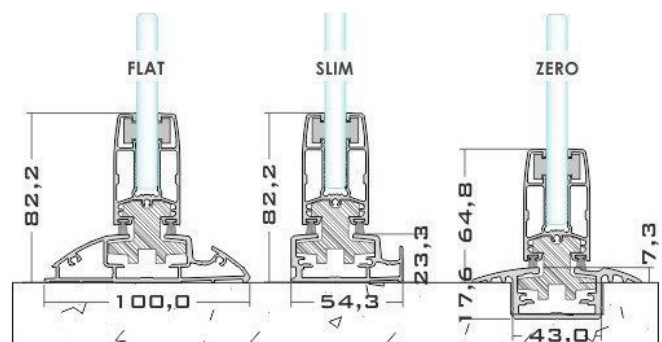
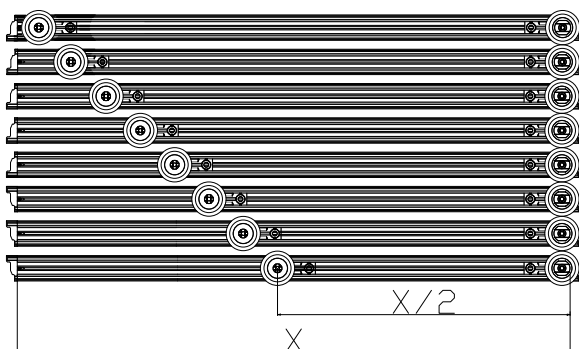
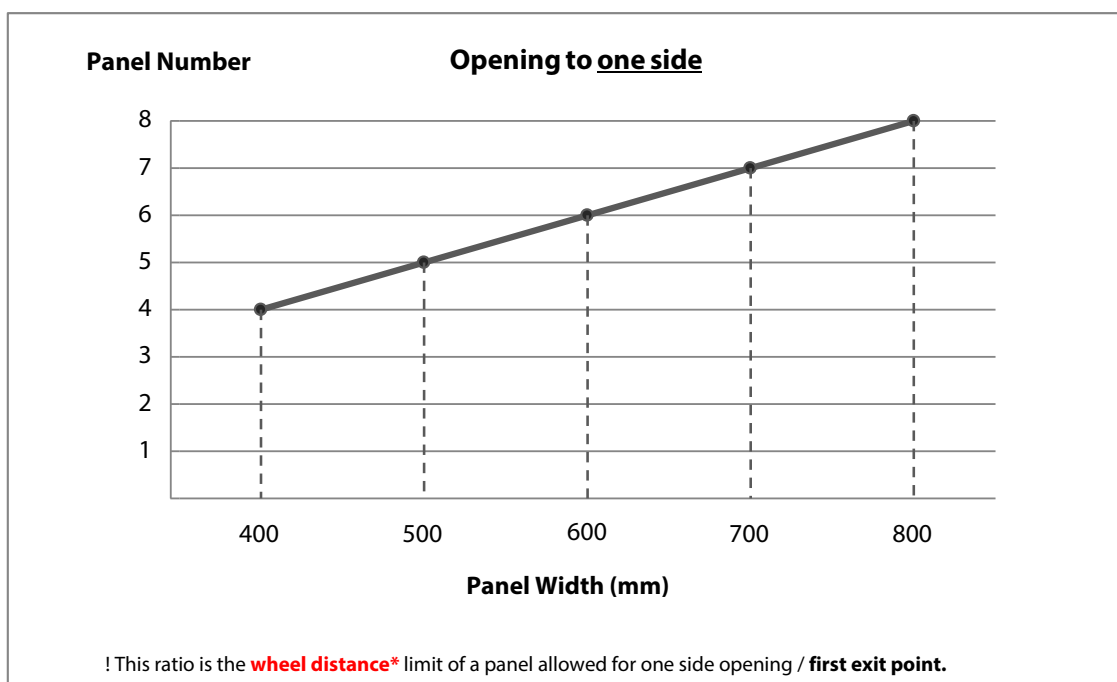

* If the wheel distance is less than $x/2$, a **second exit point** must be calculated for the following panels.

SLIDEMASTER

System	Max. Panel Height (mm)	Max. Panel Width (mm)	Min. Panel Width (mm)	Max. Panel No. (one side)	Max. Panel No. (two sides)
Slidemaster 08	2500	1500	450	4 + add. rail	8+add. rail
Slidemaster 10	3000	1500	450	4 + add. rail	8+add. rail
Slidemaster Twin	2800	1500	450	4 + add. rail	8+add. rail
Slidemaster 08 Flat	2500	1500	450	4	8
Slidemaster 10 Flat	3000	1500	450	4	8
Slidemaster Twin Flat	2800	1500	450	4	8

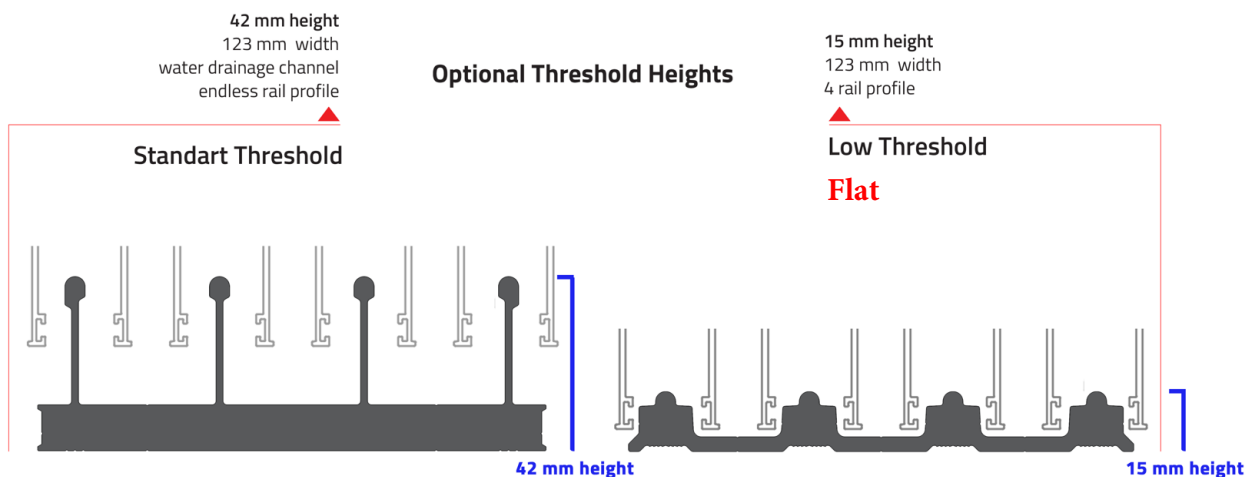
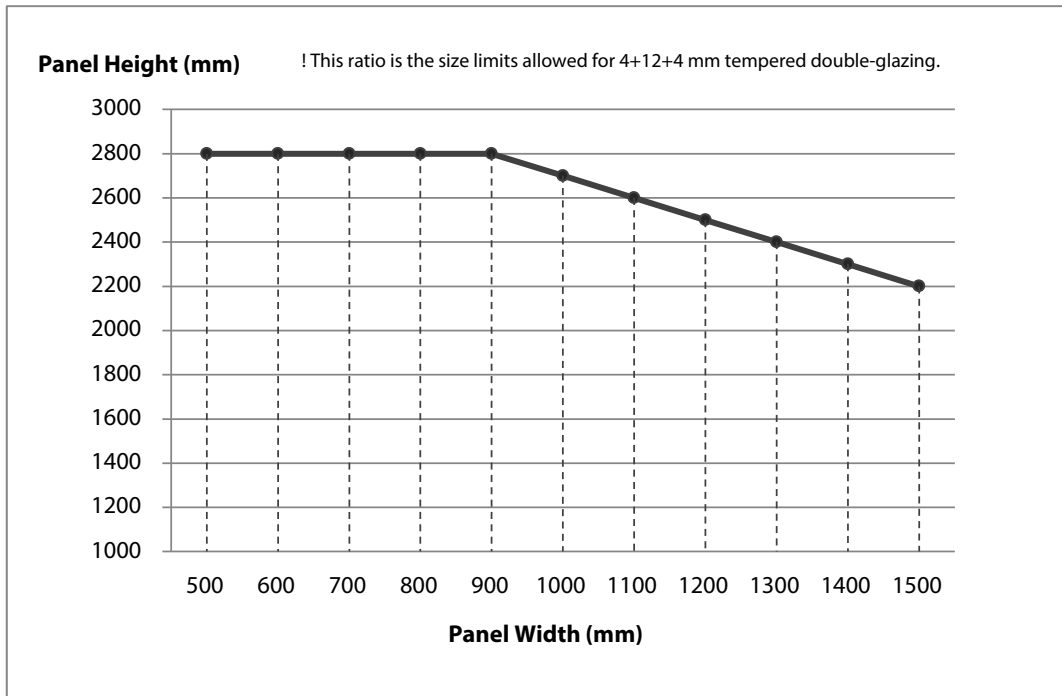

Additional Rail for Standart Threshold

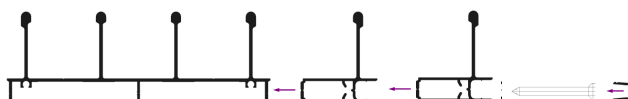

HSW - Horizontally Sliding Wall

System	Max. Panel Height (mm)	Max. Panel Width (mm)	Min. Panel Width (mm)	Max. Panel No. (one side)	Max. Panel No. (two sides)
Atrium	4000	1100*	800*	6 + 1	12+2
Momentum	3300	800	600	4,5 + 1	4,5 + 4,5
Centrum	3300	900	600	-	-

* Valid for standart parking rail zone

Atrium HD

Movable Glass Wall with Parking Area

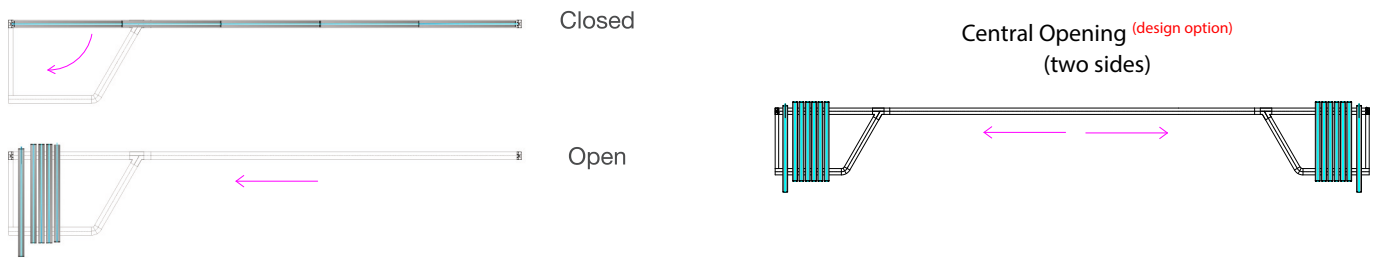

Momentum HD

Synchronized Folding System

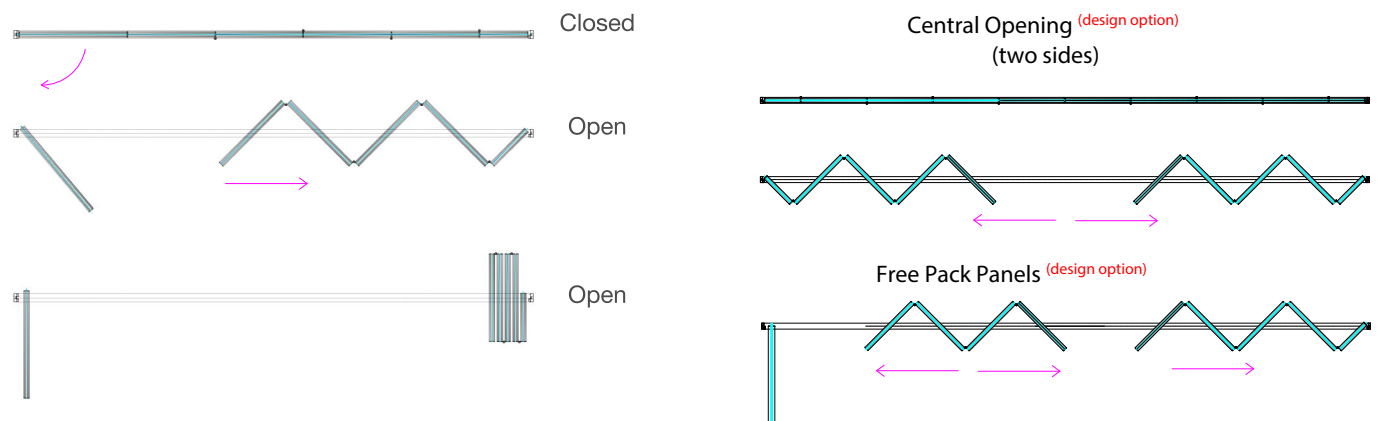

Centrum HD

Free Folding System

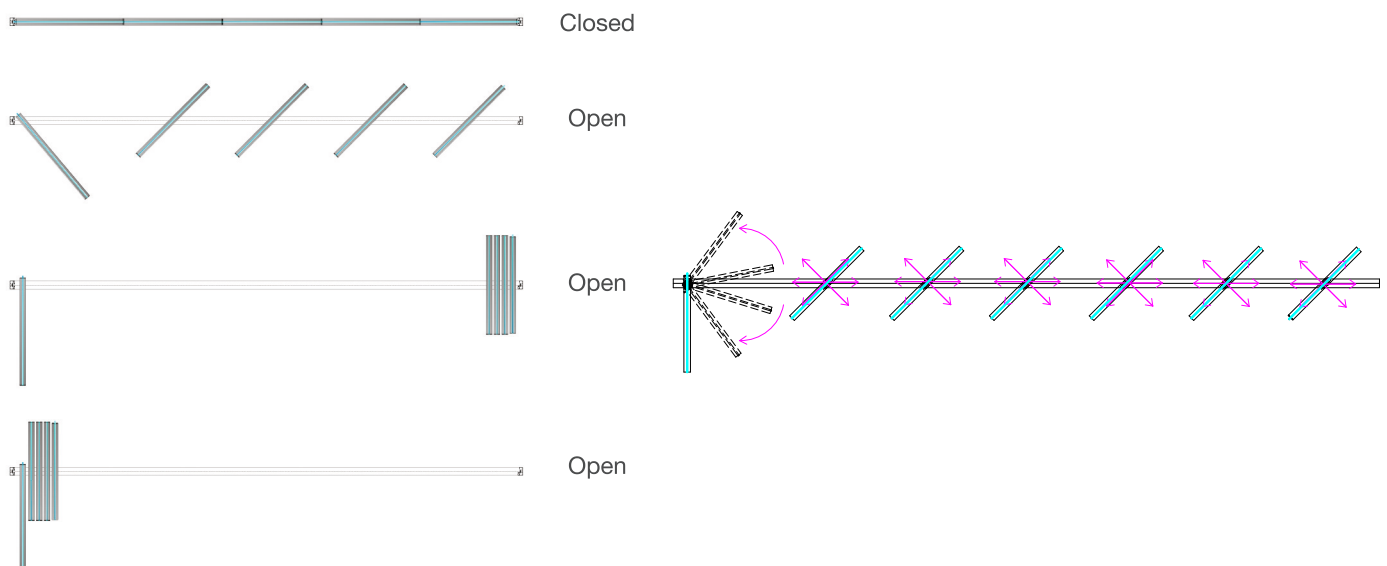

SLIDER NEXT

Slider Next-8

Width (mm) * Height (mm)	800	900	1000	1100	1200	1300	1400	1500	1600	1700
800										
900										
1000										
1100										
1200										
1300										
1400										
1500										
1600										
1700										
1800										
1900										
2000										
2100										
2200										
** 2300										
** 2400										X
** 2500									X	X

SYSTEM IS CONVENIENT.

SYSTEM IS NOT CONVENIENT.

* Min. Panel width 330mm.

** Middle and side vertical profiles must be used.



All Glass
SliderNext 8/10
Threshold Bottom Rail



All Glass
SliderNext 8/10
Flat Bottom Rail



All Isolation
SliderNext 8/10
Threshold Bottom Rail



All Isolation
SliderNext 8/10
Flat Bottom Rail

SLIDER NEXT

Slider Next-10

Width (mm) * Height (mm)	800	900	1000	1100	1200	1300	1400	1500	1600	1700
800										
900										
1000										
1100										
1200										
1300										
1400										
1500										
1600										
1700										
1800										
1900										X
2000									X	X
2100									X	X
2200									X	X
2300							X	X	X	X
2400							X	X	X	X
2500						X	X	X	X	X
2600						X	X	X	X	X
2700					X	X	X	X	X	X
** 2800					X	X	X	X	X	X
** 2900					X	X	X	X	X	X
** 3000					X	X	X	X	X	X
** 3100				X	X	X	X	X	X	X



SYSTEM IS CONVENIENT.



SYSTEM IS NOT CONVENIENT.

* Min. Panel width 330mm.

** Middle and side vertical profiles must be used.



All Glass
SliderNext 8/10
Threshold Bottom Rail



All Glass
SliderNext 8/10
Flat Bottom Rail



All Isolation
SliderNext 8/10
Threshold Bottom Rail



All Isolation
SliderNext 8/10
Flat Bottom Rail

1 FIX + 1 MOVING PANEL (2-PANEL SYSTEM)

Width (Max.) (m) \ Height (Max.) (m)	1,50	2,00	2,50	3,00	3,50	4,00
1,00						X
1,50						X
2,00						X
2,50						X
3,00						X
3,50						X
4,00						X
4,50						X

* Min. Width 850 mm.
 * Min. Height 1000 mm.
 * Glasses of Panel A and B : 8 mm Tempered Glass.
 * Height of Panel B can not be more than the height of Panel A.
 * Please use pulling support profile over 3 meter width.

1 FIX + 2 MOVING PANEL (3-PANEL SYSTEM)

Width (Max.) (m) \ Height (Max.) (m)	1,50	2,00	2,50	3,00	3,50	4,00
1,00						X
1,50						X
2,00						X
2,50						X
3,00						X
3,50						X
4,00					X	X
4,50				X	X	X

* Min. Width 850 mm.
 * Min. Height 1500 mm.
 * Glasses of Panel A, B and C : 8 mm Tempered Glass.
 * Height of Panel B and C can not be more than the height of Panel A.
 * Please use pulling support profile over 3 meter width.

SYSTEM IS CONVENIENT.

SYSTEM IS CONVENIENT. DEPENDS ON THE GLASS MANUFACTURER.

SYSTEM IS NOT CONVENIENT.

1 FIX + 1 MOVING PANEL (2-PANEL SYSTEM)

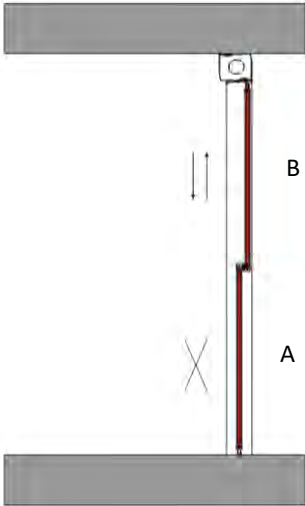

Width (Max.) (m) \ Height (Max.) (m)	1,50	2,00	2,50	3,00	3,50	4,00	4,50
1,00	Green	Green	Green	Green	Yellow	Yellow	Yellow
1,50	Green	Green	Green	Green	Yellow	Yellow	Yellow
2,00	Green	Green	Green	Green	Yellow	Yellow	Yellow
2,50	Green	Green	Green	Green	Yellow	Yellow	Yellow
3,00	Green	Green	Green	Green	Yellow	Yellow	Yellow
3,50	Green	Green	Green	Green	Yellow	Yellow	Yellow
4,00	Green	Green	Green	Green	Yellow	Yellow	Red (X)
4,50	Green	Green	Green	Green	Yellow	Red (X)	Red (X)

* Min. Width 850 mm.
 * Min. Height 1000 mm.
 * Glasses of Panel A and B : Double-Side Tempered **5+12+5 mm or 4+12+6 mm**.
 * Height of Panel B can not be more than the height of Panel A.

1 FIX + 2 MOVING PANEL (3-PANEL SYSTEM)

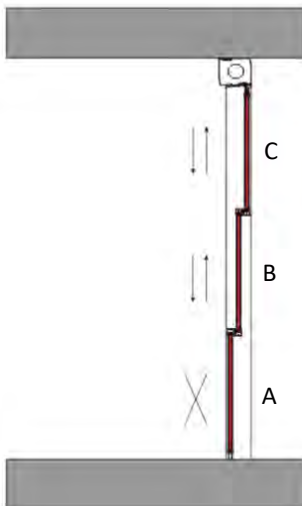

Width (Max.) (m) \ Height (Max.) (m)	1,50	2,00	2,50	3,00	3,50	4,00	4,50
1,00	Green	Green	Green	Green	Yellow	Yellow	Yellow
1,50	Green	Green	Green	Green	Yellow	Yellow	Yellow
2,00	Green	Green	Green	Green	Yellow	Yellow	Yellow
2,50	Green	Green	Green	Green	Yellow	Yellow	Yellow
3,00	Green	Green	Green	Green	Yellow	Yellow	Red (X)
3,50	Green	Green	Green	Green	Yellow	Red (X)	Red (X)
4,00	Green	Green	Green	Green	Red (X)	Red (X)	Red (X)
4,50	Green	Green	Green	Red (X)	Red (X)	Red (X)	Red (X)

* Min. Width 850 mm.
 * Min. Height 1500 mm.
 * Glasses of Panel A, B and C : Double-side Tempered **5+12+5 mm or 4+12+6 mm**.
 * Height of Panel B and C can not be more than the height of Panel A.

- SYSTEM IS CONVENIENT.
- SYSTEM IS CONVENIENT. DEPENDS ON THE GLASS MANUFACTURER.
- SYSTEM IS NOT CONVENIENT.

1 FIX + 1 MOVING PANEL (2-PANEL SYSTEM)

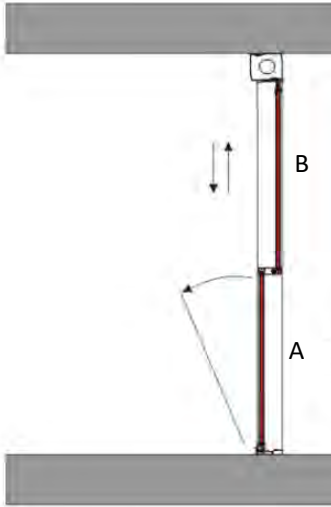

Building Floor No.	0-15 Floors						0-5 Floors		
	Width (Max.) (m)	1,00	1,50	2,00	2,50	3,00	3,50	4,00	4,50
Height (Max.)									
1,50									
2,00									
2,50									
3,00									
3,50									
4,00									X
4,50								X	X

* Min. Width 850 mm.
 * Min. Height 1400 mm.
 * Height of the Panel A must be min. 1100 mm for safety regulations. (Please check min. height limit for your country!)
 * Glass of Panel B : Double-side Tempered 5+12+5 mm or 4+12+6 mm.
 * Glass of Panel A : Inner side Laminated - Outer side Tempered 4.4.0,76+9+5 mm or 4.4.0,76+8+6 mm.
 * Height of Panel B can not be more than the height of Panel A.
 * If the building has more than 15 floors, it may be necessary to make supports to reinforce the system in accordance with the wind load values of the façade to be applied, regardless of the size of the system. For this, authorisation must be obtained by contacting the ALBERT GENAU HEAD OFFICE.

1 FIX + 2 MOVING PANEL (3-PANEL SYSTEM)

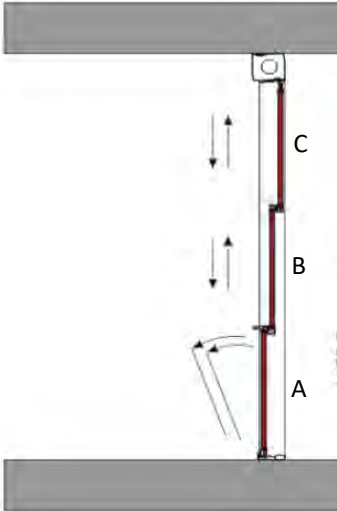

Building Floor No.	0-15 Floors						0-5 Floors		
	Width (Max.) (m)	1,00	1,50	2,00	2,50	3,00	3,50	4,00	4,50
Height (Max.)									
1,50		X	X	X	X	X	X	X	X
2,00									
2,50									
3,00									X
3,50								X	X
4,00							X	X	X
4,50						X	X	X	X

* Min. Width 850 mm.
 * Min. Height 1900 mm.
 * Height of the Panel A must be min. 1100 mm for safety regulations. (Please check min. height limit for your country!)
 * Glass of Panel B and C : Double-side Tempered 5+12+5 mm or 4+12+6 mm.
 * Glass of Panel A : Inner side Laminated - Outer side Tempered 4.4.0,76+9+5 veyá 4.4.0,76+8+6
 * Height of Panel B and C can not be more than the height of Panel A.
 * If the building has more than 15 floors, it may be necessary to make supports to reinforce the system in accordance with the wind load values of the façade to be applied, regardless of the size of the system. For this, authorisation must be obtained by contacting the ALBERT GENAU HEAD OFFICE.

SYSTEM IS CONVENIENT.

SYSTEM IS CONVENIENT. DEPENDS ON THE GLASS MANUFACTURER.

SYSTEM IS NOT CONVENIENT.

1 FIX + 1 MOVING PANEL (2-PANEL SYSTEM)

	Width (Max.) (m) Height (Max.)	1,00	1,50	2,00	2,50	3,00	3,50
	1,50						
	2,00						
	2,50						
	3,00						
	3,50						
	4,00						
	4,50						
	<p>* Min. Width 850 mm. * Min. Height 1000 mm. * Glass of Panel A and B : Double-side Tempered 5+12+5 mm or 4+12+6 mm.</p>						

1 FIX + 2 MOVING PANEL (3-PANEL SYSTEM)

	Width (Max.) (m) Height (Max.)	1,00	1,50	2,00	2,50	3,00	3,50
	1,50						
	2,00						
	2,50						
	3,00						
	3,50						
	4,00						X
	4,50					X	X
	<p>* Min. Width 850 mm. * Min. Height 1200 mm. * Glass of Panel A, B and C : Double-side Tempered 5+12+5 mm or 4+12+6 mm.</p>						

- SYSTEM IS CONVENIENT.
- SYSTEM IS CONVENIENT. DEPENDS ON THE GLASS MANUFACTURER.
- SYSTEM IS NOT CONVENIENT.

BALUMAX

System	Max. Height (mm)	Max. Distance btw Posts*	Min. Width (mm)	Max. Width (mm)
Balumax Twin	1200	1500	300	4500
Balumax 08/10	1200	1500	300	4500
Balumax INT Twin	1200	1500	300	4500
Balumax INT 08/10	1200	1500	300	4500

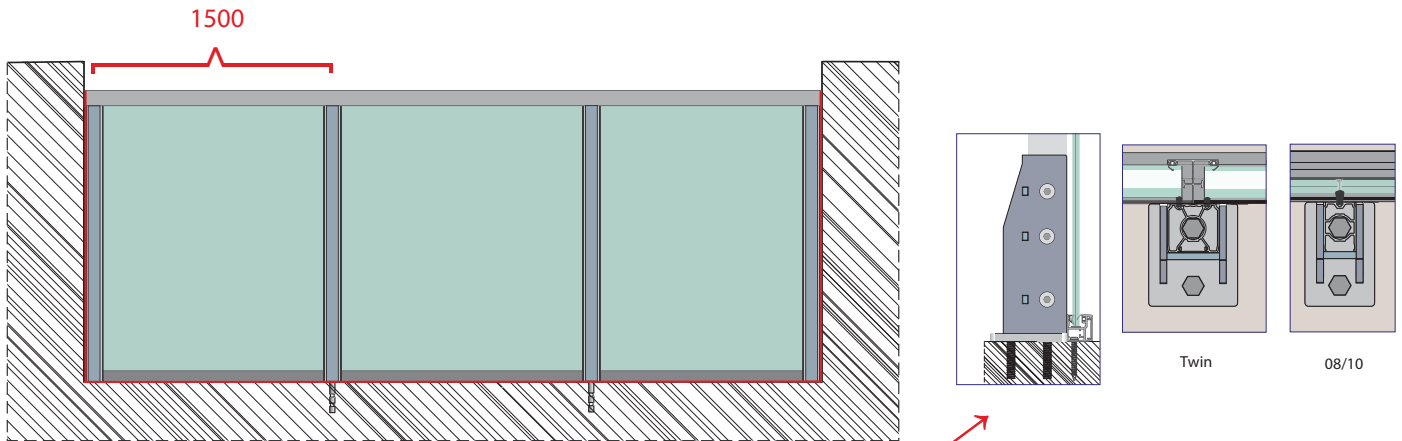

*If distance between each post is more than 1500 mm, **Extra Stiff** Installation type must be used!

BALUMAX NEXT

System	Max. Height (mm)	Max. Distance btw Posts	Min. Width (mm)
Balumax Next 08/10	1350	3000	300
Balumax Next INT 08/10	1350	3000	300

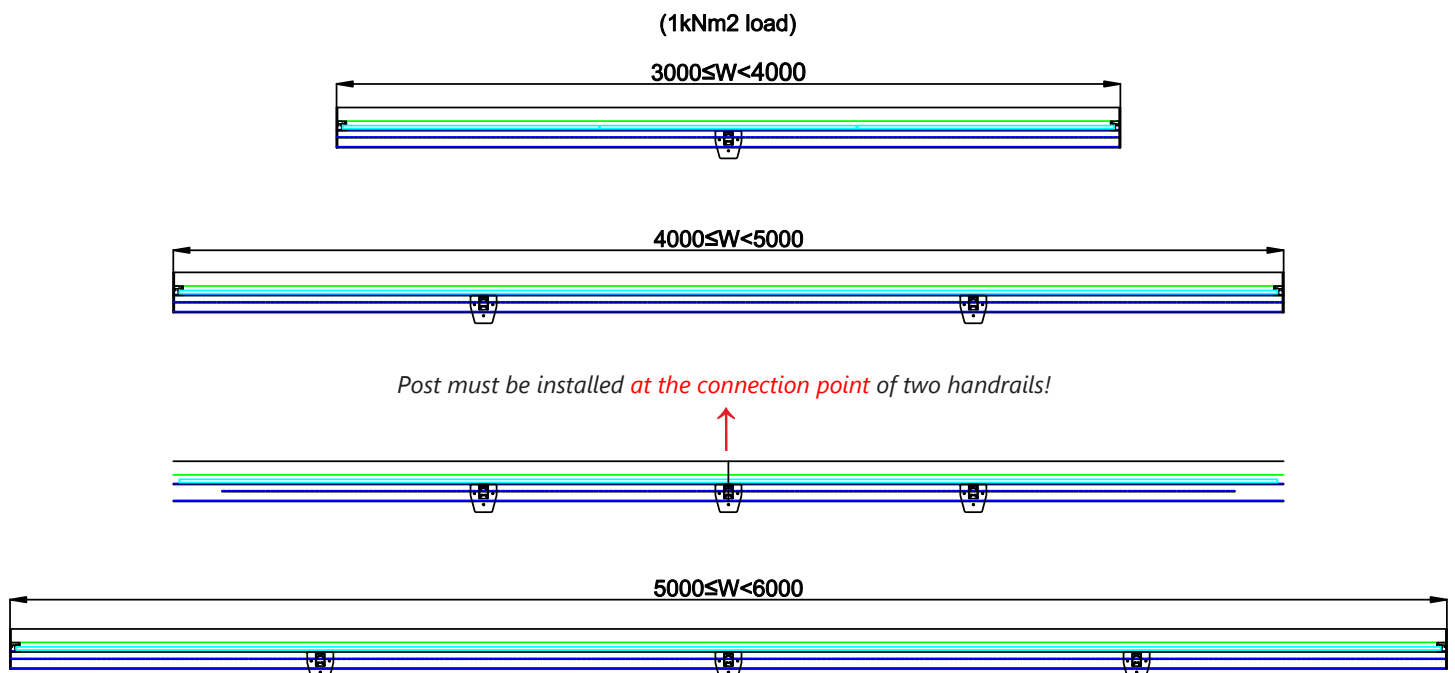

LINERA L2

System	Max. Height (mm)	Max. Rail Profile Length (mm)	Accessories Set
Liner L2 Liner	1300	3000	Standard Set / 11 pcs
Liner L2 KIT	1300	3000	KIT 150, KIT 300 (quantities are defined according to below details*)

KIT DETAIL*

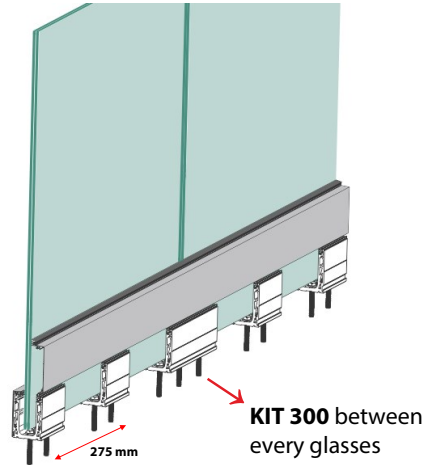
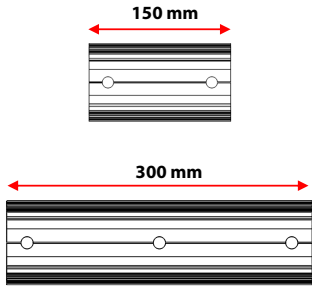

KIT 150	Quantity
Glass Width < 1000 mm	3 pcs
Glass Width < 2000 mm	6 pcs
Glass Width < 3000 mm	9 pcs

Available Glass thickness:

- 16,76 mm Laminated Glass (8 mm + 0,76 pvb + 8 mm)
- 17,52 mm Laminated Glass (8 mm + 1,52 pvb + 8 mm)
- 20,76 mm Laminated Glass (10 mm + 0,76 pvb + 10 mm)
- 21,52 mm Laminated Glass (10 mm + 1,52 pvb + 10 mm)

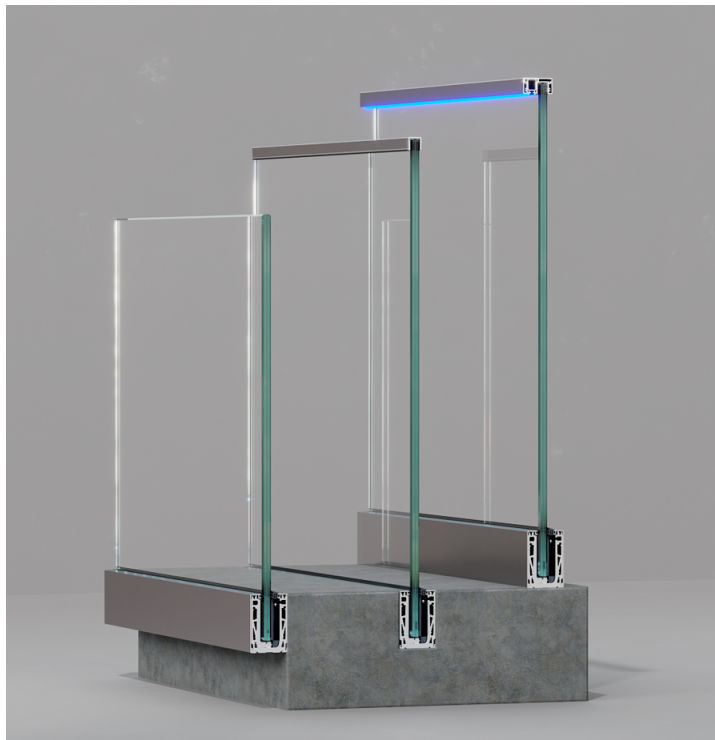

System	Width (mm)	Height Open (mm)	Height Closed (mm)
STANDARD SYSTEMS (stock dimensions)	800	1850	1130
	900	1850	1130
	1000	1850	1130
	1200	1850	1130
	1400	1850	1130
	1500	1850	1130
	1600	1850	1130
	1800	1850	1130
CUSTOM MADE SYSTEMS	510 - 790 / 810 - 890	-	-
	910 - 990 / 1010 - 1190 / 1210 - 1390	-	-
	1410 - 1490 / 1510 - 1590 / 1610 - 1790	-	-
FIX SYSTEMS	510 - 900	1130	1130
	510 - 900	1850	1850
	910 - 1400	1130	1130
	910 - 1400	1850	1850
	1410 - 1800	1130	1130
	1410 - 1800	1850	1850



* Total height will be increased 70 mm more with wheel foot type.



Movable Glass

6 mm Tempered Glass

Fix Glass

4+4 mm Laminated Glass